

# RF CONNECTORS / TNC

**RTCPC01R**

**DIMENSIONS**

**RTCJC01**

**DIMENSIONS**

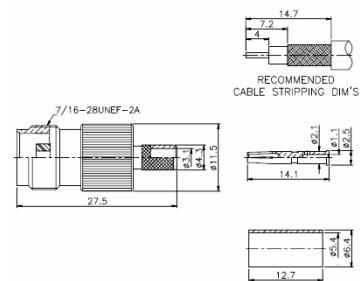
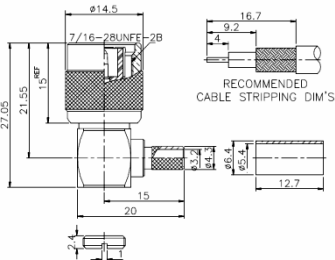

**TNC PLUG  
CRIMP  
RIGHT ANGLE**

**TNC JACK  
CRIMP  
STRAIGHT**

**RTCPC01**

**DIMENSIONS**

**RTCJQC01**

**DIMENSIONS**

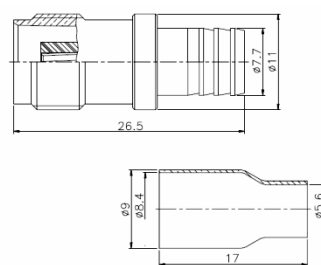
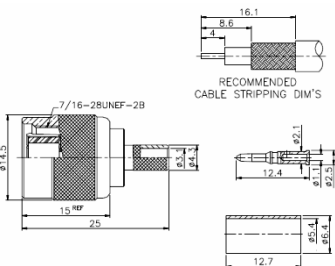

**TNC PLUG  
CRIMP  
STRAIGHT**

**TNC JACK  
QUICK CRIMP  
STRAIGHT**

**RTCPL01R**

**DIMENSIONS**

**RTCJL01**

**DIMENSIONS**

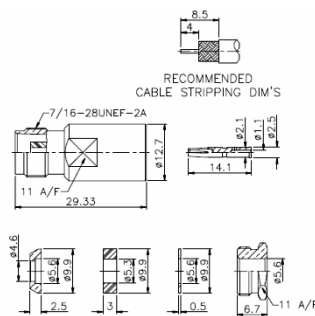
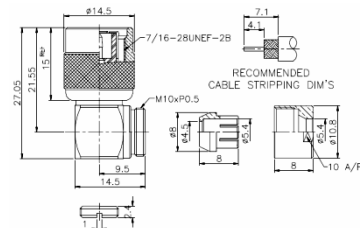

**TNC PLUG  
CLAMP  
RIGHT ANGLE**

**TNC JACK  
CLAMP  
STRAIGHT**

**RTCPL01**

**DIMENSIONS**

**RTCJCB01**



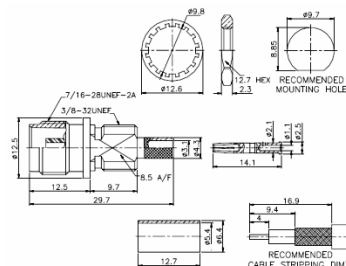
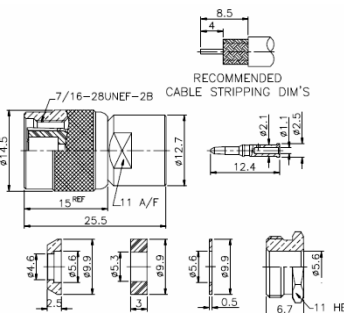







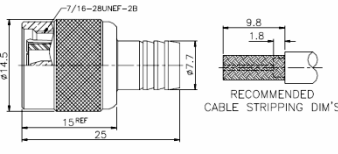

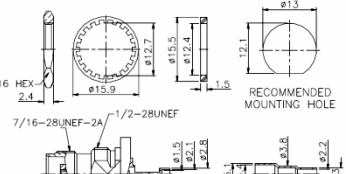
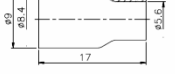
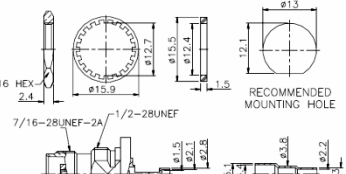

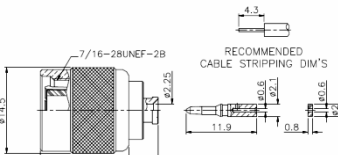
**DIMENSIONS**

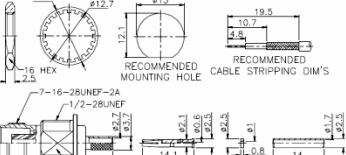
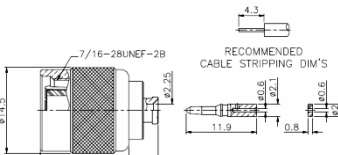
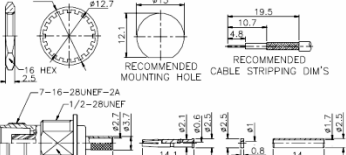

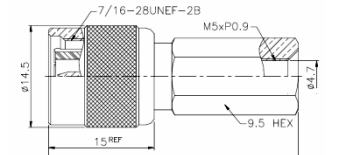
**TNC PLUG  
CLAMP  
STRAIGHT**

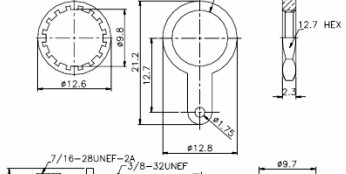
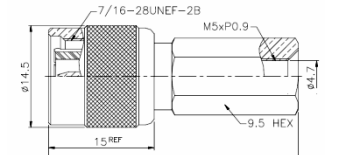
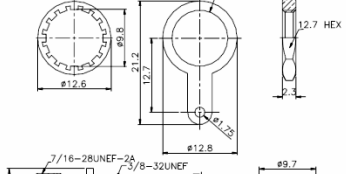
**TNC JACK CRIMP  
BULKHEAD  
STRAIGHT**

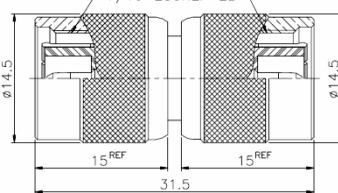
# RF CONNECTORS / TNC

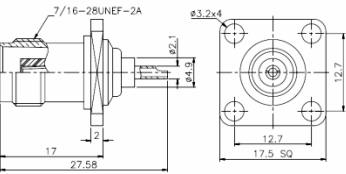
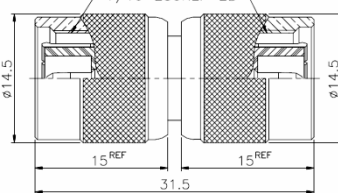
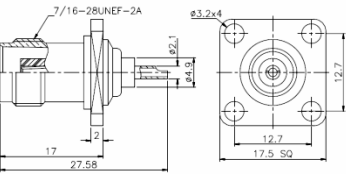
RTCPQC01	DIMENSIONS	RTCJCB02	DIMENSIONS
	 <p>RECOMMENDED CABLE STRIPPING DIM'S</p>		 <p>RECOMMENDED MOUNTING HOLE</p> <p>RECOMMENDED CABLE STRIPPING DIM'S</p>
<p>TNC PLUG QUICK CRIMP STRAIGHT</p>		<p>TNC JACK CRIMP BULKHEAD STRAIGHT</p>	 <p>RECOMMENDED MOUNTING HOLE</p> <p>RECOMMENDED CABLE STRIPPING DIM'S</p>
RTCP501	DIMENSIONS	RTCJCB101	DIMENSIONS
	 <p>RECOMMENDED CABLE STRIPPING DIM'S</p>		 <p>RECOMMENDED MOUNTING HOLE</p> <p>RECOMMENDED CABLE STRIPPING DIM'S</p>
<p>TNC PLUG SOLDER STRAIGHT</p>	 <p>RECOMMENDED CABLE STRIPPING DIM'S</p>	<p>TNC JACK CRIMP ISOLATED BULKHEAD</p>	 <p>RECOMMENDED MOUNTING HOLE</p> <p>RECOMMENDED CABLE STRIPPING DIM'S</p>
RTCPT01	DIMENSIONS	RTCJB01	DIMENSIONS
			 <p>RECOMMENDED MOUNTING HOLE</p>
<p>TNC PLUG TWIST ON STRAIGHT</p>		<p>TNC JACK RECEPT BULKHEAD STRAIGHT</p>	 <p>RECOMMENDED MOUNTING HOLE</p>
RATCP9TCP	DIMENSIONS	RTCJP01	DIMENSIONS
			
<p>TNC ADAPTOR PLUG TO PLUG STRAIGHT</p>		<p>TNC JACK RECEPT PANEL MOUNT STRAIGHT</p>	

# RF CONNECTORS / TNC

## RATCP9TCJ



TNC ADAPTOR  
PLUG TO JACK  
STRAIGHT

## DIMENSIONS

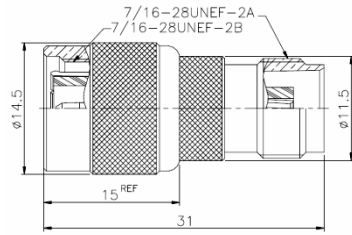

## RTCJCP01



TNC JACK CRIMP  
PANEL MOUNT  
STRAIGHT

## DIMENSIONS

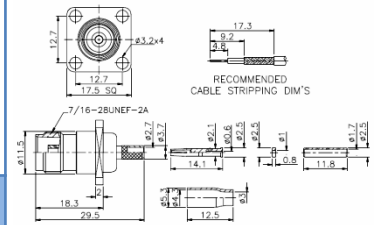

## RATCJ9TCJ



TNC ADAPTOR  
JACK TO JACK  
STRAIGHT

## DIMENSIONS

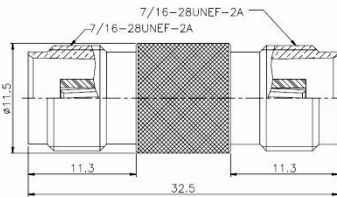

## RTCJLP01



TNC JACK CLAMP  
PANEL MOUNT  
STRAIGHT

## DIMENSIONS

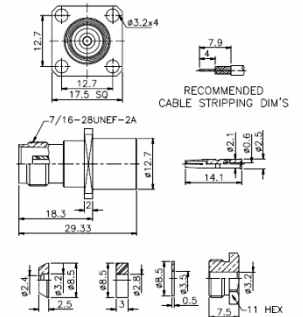

## RATCJ9TCJB



TNC ADAPTOR  
JACK TO JACK  
BULKHEAD

## DIMENSIONS

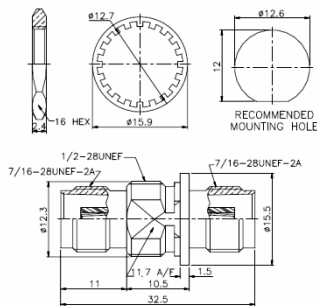

## RTCJM01



TNC JACK  
P.C.B. MOUNT  
STRAIGHT

## DIMENSIONS

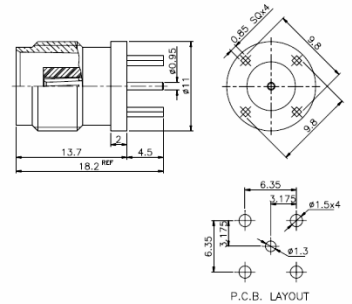

## RATCJ9TCJBI



TNC ADAPTOR  
JACK TO JACK  
ISOLATED (BLH)

## DIMENSIONS

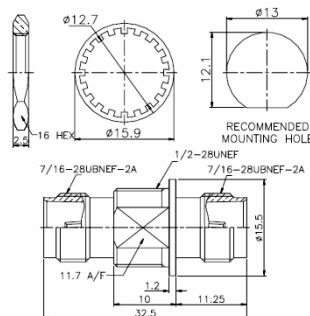

## RTCJM01R



TNC JACK  
P.C.B. MOUNT  
RIGHT ANGLE

## DIMENSIONS

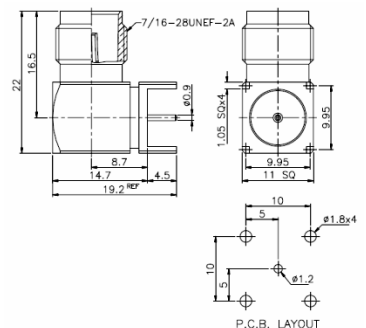

# RF CONNECTORS / TNC

**RATCP9TCJR**

**DIMENSIONS**

**RATCP92TCJT**

**DIMENSIONS**

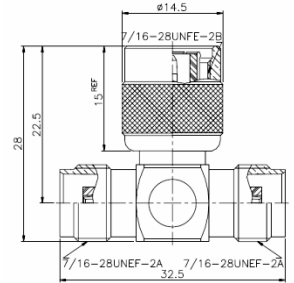
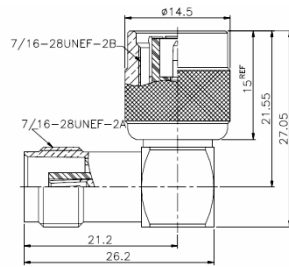

**TNC ADAPTOR  
PLUG TO JACK  
RIGHT ANGLE**

**TNC ADAPTOR  
PLUG TO 2 JACK  
T LINK**

**RATCP92TCJY**

**DIMENSIONS**

**RATCJ92TCJT**

**DIMENSIONS**

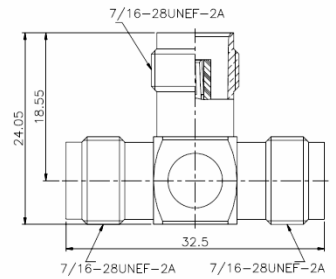
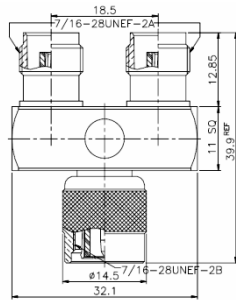

**MMCX PLUG  
CRIMP  
STRAIGHT**

**TNC ADAPTOR  
JACK TO 2 JACK  
T LINK**